

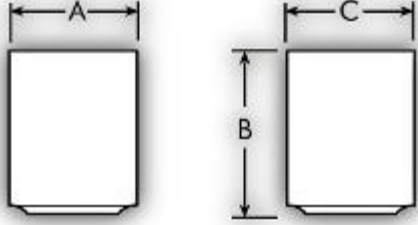

# Specifications

SKU	Projection(A)	Height(B)	Overall Width(C)	Profile
DTLB2X5X6	6"	2"	5"	<p>Technical drawing of the DTLB2X5X6 profile. It shows two views: a side view and a front view. The side view shows a rectangular profile with a height of B and a projection of A. The front view shows a rectangular profile with a width of C and a height of B.</p>
DTLB3X3X3	3 1/2"	3 7/16"	3 1/2"	<p>Technical drawing of the DTLB3X3X3 profile. It shows two views: a side view and a front view. The side view shows a rectangular profile with a height of B and a projection of A. The front view shows a rectangular profile with a width of C and a height of B.</p>
DTLB3.5X3.5X3.5	3 1/2"	3 1/2"	3 1/2"	<p>Technical drawing of the DTLB3.5X3.5X3.5 profile. It shows two views: a side view and a front view. The side view shows a rectangular profile with a height of B and a projection of A. The front view shows a rectangular profile with a width of C and a height of B.</p>
DTLB3.5X3.5X7	7 13/32"	3 1/2"	3 1/2"	<p>Technical drawing of the DTLB3.5X3.5X7 profile. It shows two views: a side view and a front view. The side view shows a rectangular profile with a height of B and a projection of A. The front view shows a rectangular profile with a width of C and a height of B.</p>

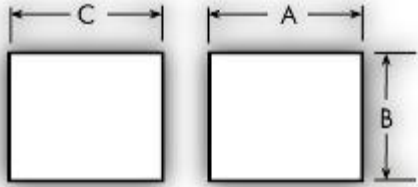
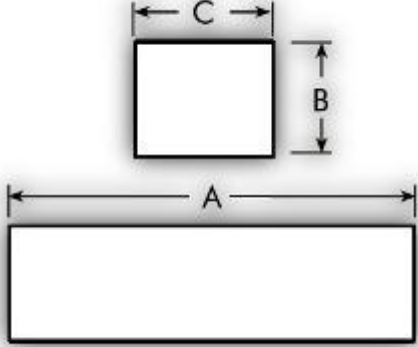

## Specifications

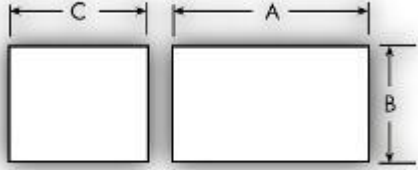
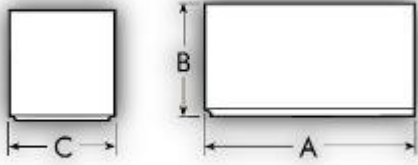
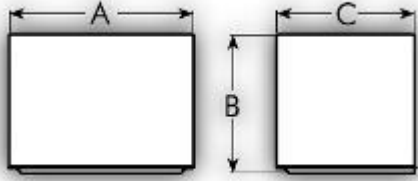
DTLB4.5X4X4	3 1/2"	4 1/2"	3 1/2"	 <p>Technical drawing of a square block. Dimension A is the width, dimension B is the height, and dimension C is the depth.</p>
DTLB5X6X6	6"	5"	6"	 <p>Technical drawing of a square block. Dimension C is the width, dimension A is the depth, and dimension B is the height.</p>
DTLB5X6X18	17 5/8"	5"	6"	 <p>Technical drawing of a rectangular block. Dimension C is the width of the top face, dimension B is the height, and dimension A is the length.</p>

# Specifications

DTLB5X6X8	8 1/2"	5"	6"	
F100	10 3/8"	5 1/2"	5"	
DTLB6X8X6	8"	6"	6"	
DTLB2X8X12	12"	1 3/4"	7 1/2"	

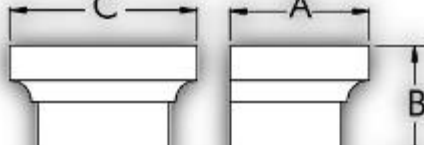
# Specifications

DTLB4X5X8	7 3/4"	3 3/8"	5"	
DTLB5X6X10	9 1/2"	4 3/4"	5 7/8"	
DTLB6X9X7	6 1/2"	5 1/2"	8 3/4"	
DTLB6X5X5	6 3/4"	5 1/2"	5"	
DTLB6X9X15	15"	6"	9 1/4"	

## Specifications

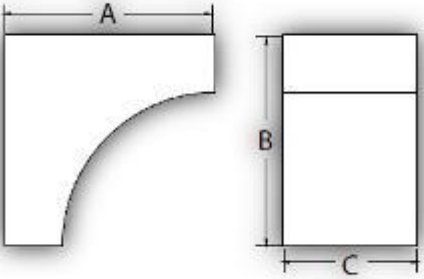
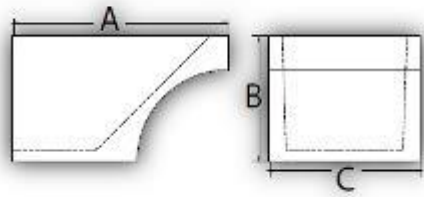
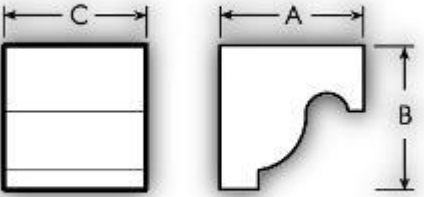
DTLB5X5X3	5 1/2"	5 1/2"	3 1/2"		
DTLB9X11X16	16"	9 1/4"	11 1/4"		
DTLB3X3X4	4 7/16"	3 11/16"	3 13/16"	N/A	

# Specifications

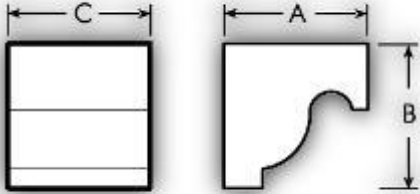
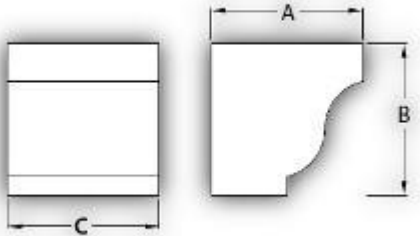
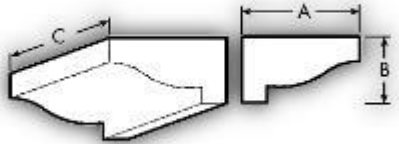
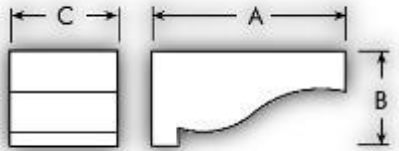
DTLB4X5X7	7 3/4"	4 1/4"	5 1/8"	N/A	
DTLB4X4X4	4"	4"	4"	N/A	
DTLB4X6X7	7 1/8"	4"	6"	N/A	
DTLB5X6X11	10 3/4"	5 1/4"	6"	N/A	

# Specifications

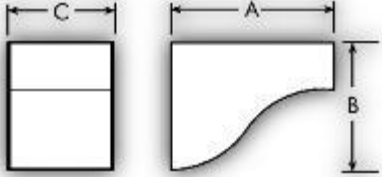
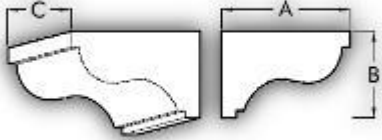
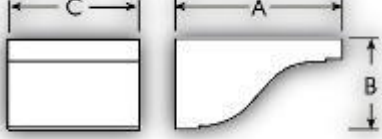
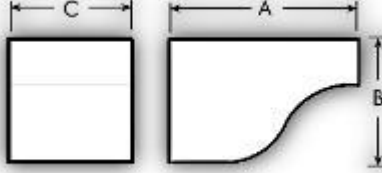
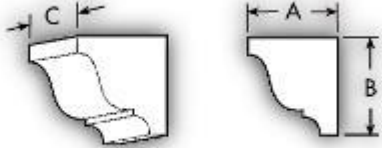

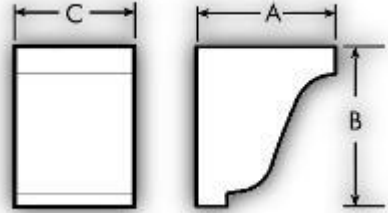
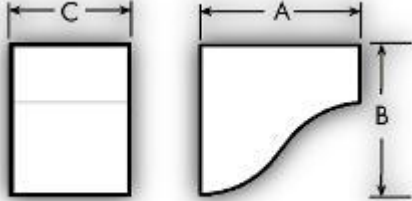
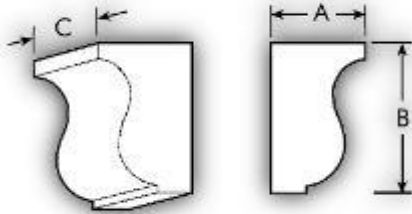
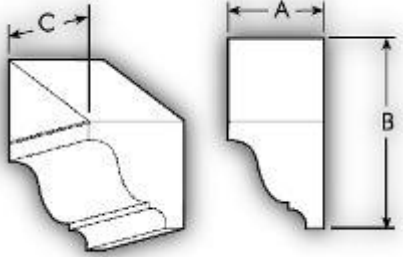

DTLB5X4X7	6 7/8"	5 3/8"	4 3/8"	N/A	
DTLB6X6X8	8"	5 3/8"	5 1/2"	N/A	
DTLB5X8X10	10"	5 3/8"	7 7/8"	N/A	
DTLB6X6X9.25	9 1/4"	6"	6"	N/A	
DTLB6X4X6	5 1/2"	6 1/8"	4 3/4"	N/A	

# Specifications

DTLB6X6X5	5 1/2"	6 1/4"	4 11/16"	N/A	
DTLB6X5X7	6 3/4"	6 5/16"	5"	N/A	
DTLB8X6X6	5 3/16"	8 1/8"	5 1/2"	N/A	
DTLB6X4X6R12	5 1/2"	10 15/16"	4 3/4"	12 / 12	

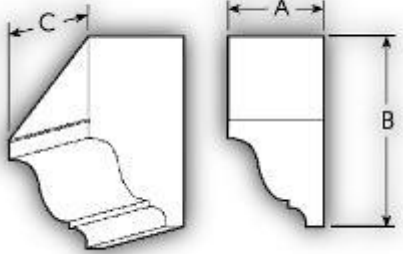

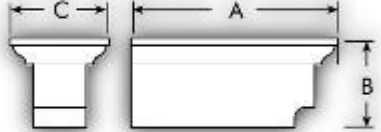

# Specifications

DTLB6X4X6L12	5 1/2"	10 15/16"	4 3/4"	12 / 12	
DTLB3X5X6	5 3/4"	3 1/8"	4 1/2"	N/A	
DTLB4X4X9	9"	3 7/8"	4 5/16"	N/A	
DTLB4X4X7	7 1/4"	4 5/16"	5"	N/A	

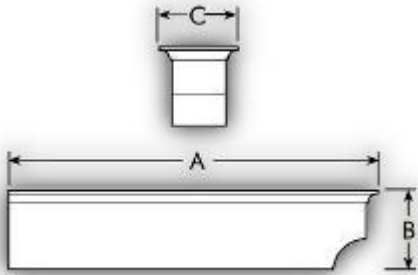
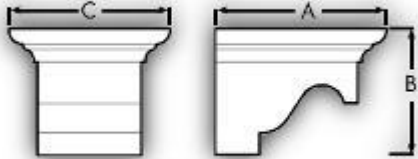
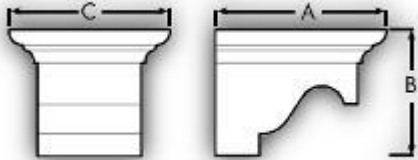
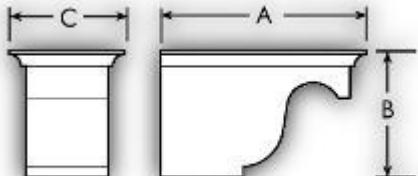
# Specifications

DTLB5X4X20	20 1/2"	4 3/8"	4 3/8"	N/A	
DTLB4X6X6	6 3/16"	4 9/16"	5 13/16"	N/A	
DTLB6X6X9	9 3/8"	5 3/4"	5 1/2"	N/A	
DTLB5X5X9	8 11/16"	5 3/8"	4 7/8"	N/A	

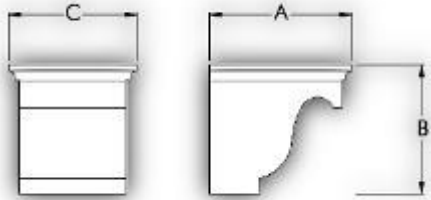
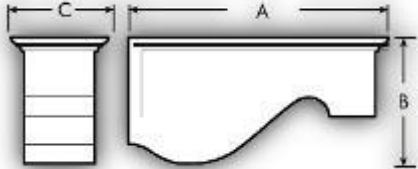
# Specifications

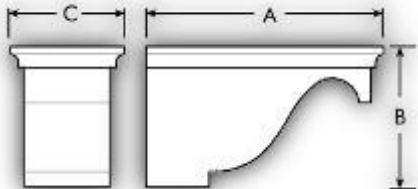
DTLB9X8X8	9"	8 1/8"	8 1/8"	N/A	
DTLB9X6X22	22"	10 5/8"	8 1/4"	N/A	
DTLB6X7X9	9 1/4"	6"	7 1/4"	N/A	
DTLB7X6X12	11 1/2"	6 3/4"	5 1/2"	N/A	

# Specifications

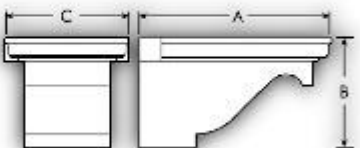
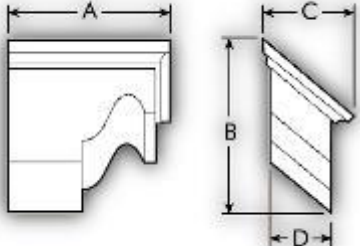
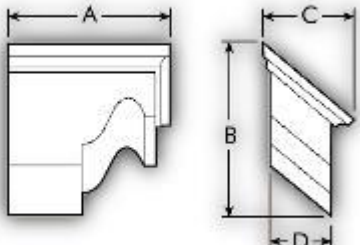
DTLB8X7X18	18"	7 3/8"	7"	N/A	
DTLB8X9X14	14"	8"	9"	N/A	
DTLB4X4X7R8	7 1/4"	6 15/16"	4 3/16"	8 / 12	
DTLB4X4X7R12	7 1/4"	8 1/4"	3 9/16"	12 / 12	

## Specifications

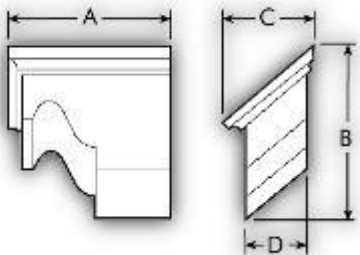
DTLB4X4X7L8	7 1/4"	6 15/16"	4 3/16"	8 / 12	
DTLB4X4X7L12	7 1/4"	8 1/4"	3 9/16"	12 / 12	